

RasaAndishan Moj Pardaz

(دانش بنیان)

رسا اندیشان موج پرداز



طراح و سازنده انواع آشکارسازهای خطی و دوربینهای تصویربرداری

- Robust & Reliable Hardware & Software Architecture
- Multi Interface Connectivity (USB2.0,USB3.0,Ethernet)
- Cross Platform - Linux & windows Based Application Support
- Great Software Improvement by MultiThreading Structure
- Various SDK (C#, C++,QT, VB.Net, MATLAB,LabVIEW) Included

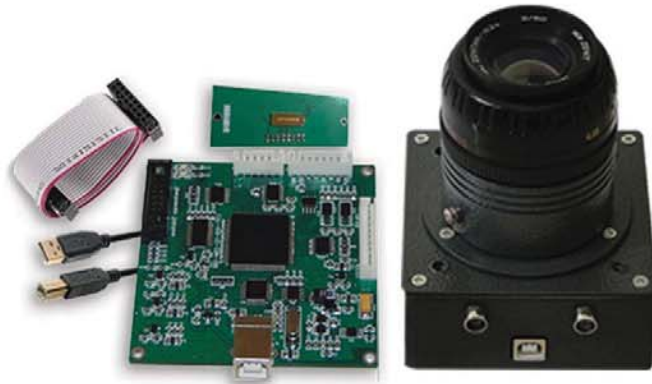
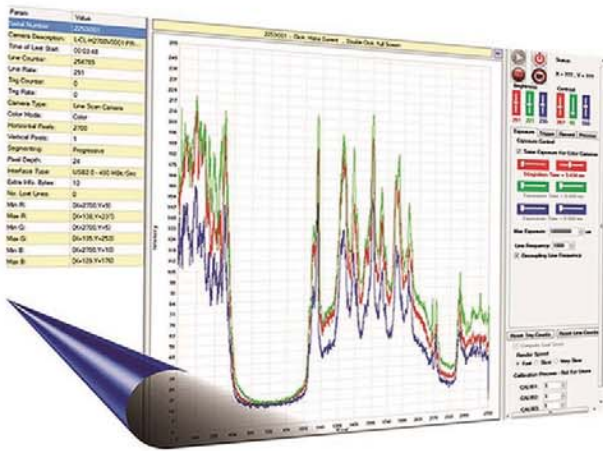

S - A - K Suffix Cameras are Board Level !
I - P Suffix Cameras are Boxed !

RA-LSC-1205



Overview

RA-LSC-1205 is a USB2.0 Bus Powered Line Scan Camera that incorporates a 2048 Pixels CCD array with Pixel Size of 14 μm by 200 μm on 14 μm center.

It is capable of detecting light in the 350 - 1100 nm range.

The Line rate of This cost effective monochrome line scan camera is up to 950 Hz.

This camera Supports External Triggering at rate of up to 475 Hz.

GUI Features

Operates up to 10 Cameras Simultaneously without loss of any data

Cross Platform Software with Auto-Detection of Compatible Cameras

Smoothing, FPN Correction, PRNU Correction, Shading Correction, Background Subtract

Best Responsiveness by Separate Threads of Data Acquisition, Processing and Monitoring

Zooming, Panning, Cursor Definition and OverLayer Mode in Line Scope

Application

RA-LSC-1205 is Designed for Applications in Optics, Imaging, Biology, Industrial Process Control and General Laboratory Use.

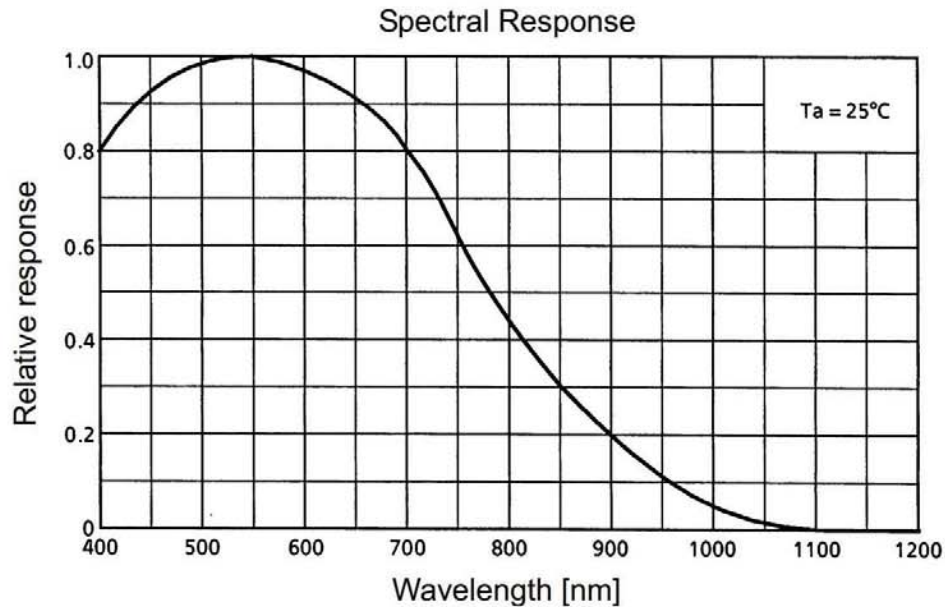

Specification

Sensor Spec	
Sensor Type	Monochrome CCD Linear Image Sensor
Spectral Response	350-1100 nm
CCD Pixel Size	14 um x 200 um
Pixel Height	200 um
Pixel Width	14 um
Effective Pixels	2048
Effective Length	2048 x 14 um = 28.672 mm
Max Pixel Frequency	2 MHz
Max Line Rate	950 Hz @ Free Running Mode
Min Exposure Time	3 us
Max Exposure Time	71 Min
Exposure Resolution	1 us
Pixel Color Depth	16 bit - 65536 Counts
Brightness Coefficient	-/+ 300 mV - 512 Analog Steps
Contrast Coefficient	64V/V - 64 Analog Steps
Triggering Spec	
Trigger Signal	TTL 5 V and 3.3 V
Trigger Mode	Free Running, Software Trigger, Hardware Trigger
Hardware Trig Polarity	Rising Edge, Falling Edge, Both Edges, High Level, Low Level
Trigger Factor	0 To 65535
Exposure Mode in Trig	Up to 4 Different Modes
Max Trigger Rate	475 Hz
Min Trigger Pulse Length	33 ns
Trigger Delay	0 to 16 Min - in 1 us Steps
General Spec	
Interface	High Speed USB 2.0 (480 Mbit/s)
Weight PCB Dimension	42 gr 80 mm x 87 mm x 25 mm
Temperature Range	- 25 to + 65 (°C)

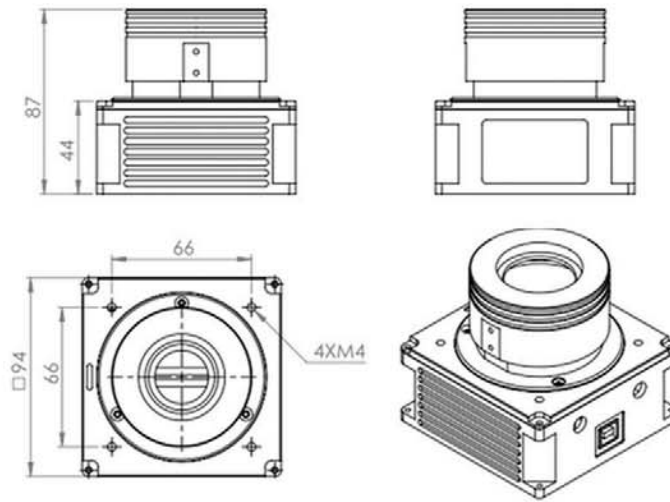

Case is available only in I suffix Versions!

Graphical User Interface

Software Features

- Line Scope and Image Scope for Scanning/Sorting/Spectroscopy Applications
- Recording is Controlled by Cache Size | Capture Size | Time or Frame Counts
- Separate Thread of Data Acquisition for Better Responsiveness to User Input
- Extremely Powerful DLL, easy to use on any platform
- Saving Frames in RAW and Jpeg Formats or any formats you tell us!

Adjustable Parameters / Supported Command

- Capture Start/Stop
- Trigger Modes: Free Running, External Trigger, Software Trigger
- Exposure Control, Exposure Mode
- Trigger Factor, Trigger Delay, Trigger Polarity, Software Triggering
- Brightness, Contrast
- Mirroring and Flipping Image only in CMOS Area Cameras
- Area of interest(AOI), Skipping and Binning only in CMOS Area Cameras
- Processing, Corrections and Filters
- Digital Output control

RasaAndishan' Cameras Comparison Table

MODEL	RA-LSC-1402I	RA-LSC-1024I	RA-LSC-1103I	RA-LSC-1209I
Resolution (HxV)	256 x 1	1012 x 1	1500 x 1	2048 x 1
Color mode	B & W	B & W	B & W	B & W
Pixel size	8 x 63.5 (μm)	7.8 x 125 (μm)	5.5 x 64 (μm)	14 x 14 (μm)
Pixel Distance	8 μm	7.8 μm	5.5 μm	14 μm
Line Width Space	63.5 μm	125 μm	64 μm	14 μm
Active Length	16.248mm	7.9 mm	8.25 mm	28.672 mm
Max Pixel Frequency	5 MHz	7.5 MHz	2 MHz	15 MHz
Max Line Frequency	19157 Hz	7089 Hz	641 Hz	7143 Hz
Max Trig Frequency	9578 Hz	3544 Hz	320 Hz	3571 Hz
CCD Dynamic Range	4000	1900	200	2000
Electronic Shutter	X	✓	✓	X
Exposure Control	✓	✓	✓	✓
Exposure Min	52 μs	1 μs	10 μs	140 μs
Exposure Max	14.5 Min	71 Min	14 Min	8.5 Min
ADC Resolution	16 Bit	16 Bit	16 Bit	16 Bit
Contrast Adjust	✓	✓	✓	✓
Brightness Adjust	✓	✓	✓	✓
Adaptor Mount	M42	M42	M42	M42
External Power	X	X	X	X
Temperature Range	0 to +70 (°C)	-25 to +65 (°C)	-25 to +60 (°C)	-25 to +65 (°C)

RasaAndishan' Cameras Comparison Table

MODEL	RA-LSC-0511I	RA-LSC-0551I	RA-LSC-0751I	RA-LSC-1205I
Resolution (HxV)	2048 x 1	2048 x 1	2048 x 1	2048 x 1
Color mode	B & W	B & W	B & W	B & W
Pixel size	14 x 200 (μm)	14 x 14 (μm)	14 x 14 (μm)	14 x 200 (μm)
Pixel Distance	14 μm	14 μm	14 μm	14 μm
Line Width Space	200 μm	14 μm	14 μm	200 μm
Active Length	28.672 mm	28.672 mm	28.672 mm	28.672 mm
Max Pixel Frequency	2 MHz	4 MHz	5 MHz	2 MHz
Max Line Frequency	950 Hz	1905 Hz	2376 Hz	950 Hz
Max Trig Frequency	475 Hz	952 Hz	1188 Hz	475 Hz
CCD Dynamic Range	267	6000	6000	400
Electronic Shutter	X	X	✓	✓
Exposure Control	✓	✓	✓	✓
Exposure Min	1056 μs	525 μs	1 μs	3 μs
Exposure Max	35.5 Min	17.5 Min	14 Min	35.5 Min
ADC Resolution	16 Bit	16 Bit	16 Bit	16 Bit
Contrast Adjust	✓	✓	✓	✓
Brightness Adjust	✓	✓	✓	✓
Adaptor Mount	M42	M42	M42	M42
External Power	X	X	X	X
Temperature Range	-10 to +60 (°C)	-10 to +55 (°C)	-10 to +55 (°C)	-25 to +60 (°C)

RasaAndishan' Cameras Comparison Table

MODEL	RA-LSC-3753I	RA-LSC-2113I	RA-LSC-1254I	RA-LSC-2253I
Resolution (HxV)	2088 x 1	2098 x 3	2500 x 1	2700 x 3
Color mode	B & W	RGB	B & W	RGB
Pixel size	14 x 14 (μm)	14 x 14 (μm)	5.25 x 64 (μm)	10.5 x 10.5 (μm)
Pixel Distance	14 μm	14 μm	5.25 μm	10.5 μm
Line Width Space	14 μm	14 μm 112 μm	64 μm	10.5 μm 42 μm
Active Length	29.232 mm	29.372 mm	13.125 mm	28.35 mm
Max Pixel Frequency	2 MHz	5 MHz	2 MHz	5 MHz
Max Line Frequency	940 Hz	2326 Hz	385 Hz	1799 Hz
Max Trig Frequency	470 Hz	1163 Hz	192 Hz	899 Hz
CCD Dynamic Range	375	6300	400	300
Electronic Shutter	X	✓	✓	X
Exposure Control	✓	✓	✓	✓
Exposure Min	1064 μs	1 μs	10 μs	556 μs
Exposure Max	35.5 Min	71 Min	14 Min	71 Min
ADC Resolution	16 Bit	16 Bit	16 Bit	16 Bit
Contrast Adjust	✓	✓	✓	✓
Brightness Adjust	✓	✓	✓	✓
Adaptor Mount	M42	M42	M42	M42
External Power	X	X	X	X
Temperature Range	-25 to +65 (°C)	-10 to +60 (°C)	-25 to +60 (°C)	0 to +60 (°C)

RasaAndishan' Cameras Comparison Table

MODEL	RA-LSC-0526I	RA-LSC-1304I	RA-LSC-0553I	RA-LSC-0718I
Resolution (HxV)	3000 x 1	3648 x 1	5150 x 1	5363 x 3
Color mode	B & W	B & W	B & W	RGB
Pixel size	7 x 200 (μm)	8 x 200 (μm)	7 x 7 (μm)	8 x 8 (μm)
Pixel Distance	7 μm	8 μm	7 μm	8 μm
Line Width Space	200 μm	200 μm	7 μm	8 μm 64 μm
Active Length	21 mm	29.184 mm	36.05 mm	42.904 mm
Max Pixel Frequency	1 MHz	1 MHz	5 MHz	1 MHz
Max Line Frequency	325 Hz	270 Hz	951 Hz	184 Hz
Max Trig Frequency	162 Hz	135 Hz	475 Hz	92 Hz
CCD Dynamic Range	320	300	6666	10670
Electronic Shutter	✓	✓	X	✓
Exposure Control	✓	✓	✓	✓
Exposure Min	1 μs	1 μs	1051 μs	2 μs
Exposure Max	35.5 Min	71 Min	14.5 Min	71 Min
ADC Resolution	16 Bit	16 Bit	16 Bit	16 Bit
Contrast Adjust	✓	✓	✓	✓
Brightness Adjust	✓	✓	✓	✓
Adaptor Mount	M42	M42	M42	M42
External Power	X	X	X	X
Temperature Range	-10 to +60 ($^{\circ}\text{C}$)	-25 to +65 ($^{\circ}\text{C}$)	-10 to +60 ($^{\circ}\text{C}$)	-10 to +55 ($^{\circ}\text{C}$)

RasaAndishan' Cameras Comparison Table

MODEL	RA-LSC-1707I	RA-LSC-0532I	RA-LSC-2950I	RA-LSC-2950P
Resolution (HxV)	3725 x 2	3750 x 2	10680 x 3	21360 x 1
Color mode	B & W	B & W	RGB	B & W
Pixel size	4.7 x 4.7 (μm)	7 x 7 (μm)	2.8 x 4 (μm)	2.8 x 4 (μm)
Pixel Distance	4.7 μm	7 μm	4 μm	4 μm
Line Width Space	4.7 μm	7 μm	2.8 μm 64 μm	2.8 μm
Active Length	35.015 mm	52.5 mm	42.720 mm	42.720 mm
Max Pixel Frequency	7.5 MHz	4 MHz	5 MHz	5 MHz
Max Line Frequency	1968 Hz	1050 Hz	230 Hz	230 Hz
Max Trig Frequency	984 Hz	525 Hz	115 Hz	115 Hz
CCD Dynamic Range	1800	8333	7000	7000
Electronic Shutter	X	X	X	X
Exposure Control	✓	✓	✓	✓
Exposure Min	508 μs	952 μs	2326 μs	2326 μs
Exposure Max	35.5 Min	17.5 Min	14.5 Min	14.5 Min
ADC Resolution	16 Bit	16 Bit	16 Bit	16 Bit
Contrast Adjust	✓	✓	✓	✓
Brightness Adjust	✓	✓	✓	✓
Adaptor Mount	M42	M42	M42	M42
External Power	X	X	X	X
Temperature Range	0 to +60 (°C)	-25 to +65 (°C)	0 to +60 (°C)	0 to +60 (°C)

RasaAndishan' Cameras Comparison Table

MODEL	RA-ASC-0134I	RA-ASC-0267I	RA-ASC-9031I	RA-ASC-5000I
Sensor Type	CMOS	CCD	CMOS	CMOS
Resolution (HxV)	1280 x 960	1360 x 1024	2592 x 1944	2592 x 2048
Resolution	1.2MP	1.4 MP	5 MP	5 MP
Color mode	Color	Color	Color	Color
Pixel size (HxV)	3.75 x 3.75 (µm)	4.65 x 4.65 (µm)	2.2 x 2.2 (µm)	4.8 x 4.8 (µm)
Sensor Size (HxV)	4.8 x 3.6 (mm)	7.6 x 6.2 (mm)	5.7 x 4.28 (mm)	12.44 x 9.8 (mm)
Max Pixel Frequency	75 MHz	15 MHz	70 MHz	400 MHz
Shutter Type	Global Shutter	Global Shutter	Rolling Shutter	Global Shutter
Interface	USB3.0	USB2.0	USB3.0	USB3.0
Frame Rate @ ResM	55 Hz	8 Hz	10.5 Hz	60 Hz
Light Spectrum	Visible	Visible	Visible	Visible
Exposure Control	✓	✓	✓	✓
AOI Support	✓	X	✓	✓
Frame Rate @ AOI	up to 457 Hz	---	up to 523 Hz	up to 20000 Hz
ADC Resolution	12 Bit	16 Bit	8 Bit	8 Bit
Contrast Adjust	✓	✓	✓	✓
Brightness Adjust	X	✓	X	X
Adaptor Mount	CS-Mount	CS-Mount	CS-Mount	CS-Mount
External Power	X	X	X	X
Temperature Range	-30 to +70 (°C)	-10 to +55 (°C)	-30 to +70 (C)	-30 to +70 (°C)



حکیمیه، میدان فجر، خیابان خرم، خیابان سحر، کوچه پگاه ۶، پلاک ۱۱، واحد ۷

🌐 www.RasaAndishan.ir ✉ Info@RasaAndishan.ir ☎ 021-77013687