



Innovator In Spectroscopy Equipment

SPECT2113



CFP PORTABLE SPECTROMETER
SPECT2113 - SN 130424 - 001
MADE IN IRAN



**DIGITAL PORTABLE
SPECTROMETER
MODEL SPECT2113**

www.cfp.co.ir



CATALOG



SPECTROMETER



FREE DOWNLOAD

DIGITAL PORTABLE SPECTROMETER

MODEL SPECT2113

Features

- High spectral resolution
- NaI(Tl) detector, 103cm³ (6.3in³)
- Auto Calibration with ¹³⁷Cs
- KML output for GIS software
- Large full color 4.3inch display
- Unique Full Spectra Analysis method
- Audio output with the adjustable threshold
- Assay mode readout in K (%), U and Th (ppm)
- Auto-stabilizing on naturally occurring radio elements
- Special rugged design to withstand typical field usage
- 2D and 3D radioactive mapping with an Internal GPS
- Recording and storing measurement result and spectra in memory
- Capability of connecting to PC over USB interface for data transfer
- Automatic logging of scan data with GPS-referencing for further analysis

**FAST AND ACCURATE RESULTS
VIA FULL SPECTRA ANALYSIS
METHOD**



Description

The SPECT2113 Spectrometer from Control Farayand Pasargad (CFP) is the state-of-the art portable hand-held radiation survey meter device for using in the geophysical industry, health physics, homeland security industries, etc. It offers an integrated design with a NaI(Tl) detector for high sensitivity, direct survey readout, audio output, full weather protection, ease of use and highest sensitivity in the market segment.

The spectrometer is auto-stabilized on the naturally occurring radioactive materials (K, U, & Th) and does not require any test sources. This convenient handheld instrument offers the equivalent performance of much larger, and costlier, portable units. Because of utilizing full spectra analysis method SPECT2113 presents half relative uncertainty in analysis results in comparison to the other devices with the same crystal size.

Survey and Scan Modes

Total Count Readout is 10/sec rate in the Survey Mode or can be adjusted (1 - 10 sec) in the Scan Mode. The unit has an integrated mapping capability using an internal. This scan capability enables the users to move through a large area with the unit recording data at typically a one reading per second rate with GPS location. Companion software then permits a map to be made with high precision in the positioning of data points. When used with a GPS receiver, data can be stored and profiles are produced which is ideal for both area surveying and drilled core.

Assay Mode

The Assay mode provides the concentrations of K, U, and Th as shown in the display below. The sample time is selected by the user from 30 seconds and up; in most cases 120 seconds 1s sufficient. In Assay mode the complete 4096 channel sample spectra and the results of the calculation of concentrations (plus position data if available) are stored for later retrieval. The user can select the desired sampling time.

On-fly-assays

In Scan mode, the user can select the scan data rate for recording assays together with total counts. These on-fly assays do not store complete spectra but only the average assays over the scan period.

Specifications

Input(s)

Power Jack

19V (2A) DC adaptor

USB

5V DC for PC communication

Output(s)

No output signal

Control(s)

Power

Power push button to turn PC on or off

Function Key

Four push button function key (thumb activated)

Indicator(s)

Power

Power on indicator

Battery status in 3 color (red, orange, green)

Ring

Green ring

Alarm

Audio via miniature speaker, Variable audio threshold set point and Audio voice proportional to the count rate

Logo

CFP logo indicator (full color)

Display

Large Full Color Graphic LCD

4.3", 800 x 480 pixels

Full color LCD display

Easily view log files with no need to connect to a computer

Performance

Resolution

<7.5% FWHM @ 662 keV

Count Rate

Maximum 250,000 CPS (0.5mSv/h)

Readout

Search Mode	Counts in CPS from 0 to 250k and Hist 32bit x 4096
Assay mode	Display in K (%), U and Th (ppm) (ROIs according to IAEA)

Gamma Sensitivity

2CPS/nSv/h

Energy Response

20 - 3000 keV

Internal Sampling

10 /second

Coefficient of Variation (CV)

3.80% @ 150 CPS

1.94% @ 500 CPS

1.23% @ 1500 CPS

0.50% @ 5000 CPS

0.49% @ 15000 CPS

Detector

gammaNaI(Tl), 2" x 2" (\emptyset x H) cylindrical**PMT**

14-pin 10-stage PMTs

Data Acquisition and Analysis**OS**

Built in Windows 7 or higher versions

Software

SPECT2113 (SOFTWARE)

Measurement/Spectrum**High Voltage**

0-2000V, Positive, 12 Bit resolution

Energy Calibration

Linear calibration

Auto-calibration

Auto-stabilization

Spectrum

32bit x 4096 channel

Cumulative spectrums

ADC**Channels**

12bit in 4096Ch @80Mhz FRQ

Conversion time

250nsec with 12.5nsec time interval

Digital Signal Processing (internal setting)

12-bit and 80 MHz ADC

Charge sensitive preamplifier gain:10-150mV/pc

Amplifier coarse gain: (x1 to 150x) in 15 step

Amplifier fine gain: (0 - 2x) in 65536 step

Integration time filter for the energy calculation with software adjustable rise time in the range 0 to 0.819ms @80Mhz in 0-65536 step

Trigger threshold software adjustment (0 to 100% scale) in 1024 step

Software fine tuning of the Pole-Zero cancellation

Software gain stabilization

Pile-up rejection and Live Time correction

Baseline restorer with programmable averaging

Battery**Standard**

Internal battery pack module (3 cell Li-ion)

Rechargeable Life: over 5 hours at 20°C in full performance

Backup

Backup battery pack kit (4 cell Li-ion)

Life: over 5-6 hours at 20°C in full performance

Device

8-10 hour Standard and backup battery life

Memory

Huge 40GB SSD

Storage unlimited Total Count, Scan, Assay, plus full spectrum in 32bit x 4096

Certificate

CE

Compliant to IEC 61010-1:2010

This Certificate of Compliance can be checked for validity at <https://cfp.co.ir/download.ashx?file=Digital-Portable-Spectrometer-SPECT2113-CE.pdf>**Application**

- Core scanning
- Laboratory assays
- Baseline surveying
- Emergency situations
- Dose rate measurement
- Radioactive waste control
- Customs and border control
- Accurate inspection of lading
- Nuclear medicine and industry
- Safe disposal of nuclear waste
- Environmental waste monitoring
- Radiation monitoring and mapping
- Exploration for Uranium and Thorium
- Radiation monitoring in building industry
- Scientific Research and Research activities
- Radioactive sources and materials traffic control
- Geological and raw material survey (uranium ore)
- Determination of concentrations of natural radioactive elements (K %, U and Th ppm)
- Construction material and products radiation monitoring Absorbance, Reflectance & Transmission



Electrical, Mechanical and Environmental

Power required	
Standard version +19V (2A) DC adaptor	
Physical	
Dimensions	package style: 45 x 35 x 20 cm (L x W x H) spectrometer: 27 x 15 x 10 cm (L x W x H)
Weight	without batteries: 2.28kg with batteries: 2.68kg Shipping: 10.94kg
Storage temperature	-20°C to 50°C
Operating temperature	-10°C to 50°C.
Relative Humidity	10 to 80%

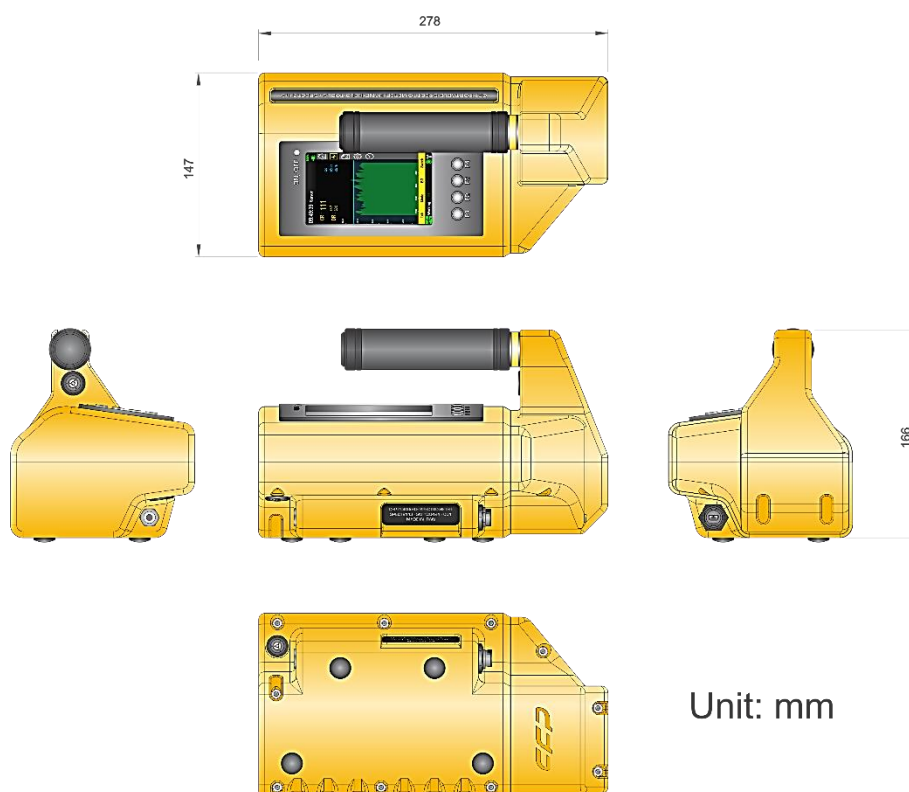

SPECT2113-Mechanical

Software and user interface

Device GUI

SPECT2113 can be used standalone using the companion 4.3inch display. In the following we see the most important window in the device GUI.

Figure 1: MAIN panel: Presenting analysis results K%, Uppm, Th(ppm), total rate, date, time, working mode, battery, alarm, GPS status and element result .

Figure 2: Graph panel: Presenting real-time gamma spectrum data with peak position marking in the first mode and the second mode showing survey data graph with threshold level (Figure 3)

Figure 4: GPS panel: GPS status with speed

Figure 5: LOG panel: Visualize files and folders in the device storage

Figure 6: Setting panel: Analysis, survey and device settings with device description

Figure 7: Date/Time panel: Adjusting date and time with auto update option via GPS data

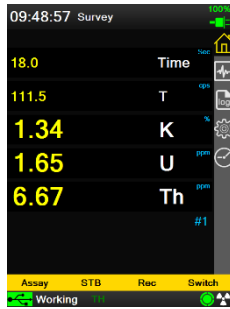

Figure 1



Figure 2

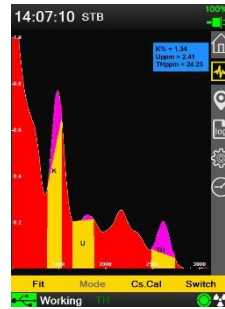

Figure 3

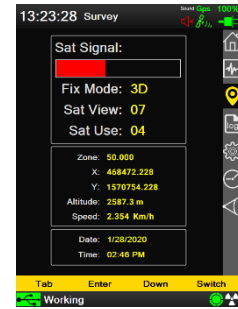

Figure 4

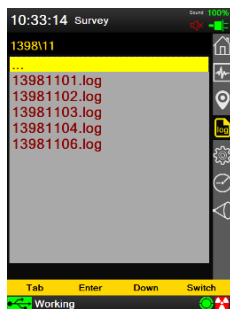

Figure 5

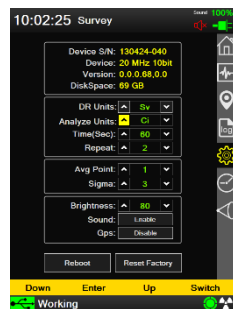

Figure 6

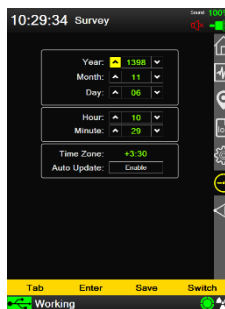

Figure 7

SPECT2113 GUI

PC software

SPECT2113 (SOFTWARE)

The SPECT2113 is provided with utility software to download the data that is stored in internal memory. All the stored files including log, MCA and GPS related files can be downloaded to the PC via USB. The program also gives graphical and numerical views of the data. The raw data (4096 channel) can also be re-exported as a text file for further processing.

Input /Output (Using supplied CFP-Analysis software)

USB

Wi-Fi (OPT)

Data Output formats

CSV, TXT, MCA, KML, XLS, LOG

SPECT2113 PC Interface

Device Tools Local Tools Backup Help

Connect Disconnect Refresh Download Erase EraseAll

Year : Month : Sync ALL Data

Select all Select none

Search & Filter Files List Option

Device	#130424-040	All	Local Device	130424-040	All
	Files	Status	Last Update	Files	Size (KB) Last Update Time
<input type="checkbox"/>	0 13990324-Survey.I...	OK	2020/06/13	<input type="checkbox"/>	13981212-Survey.log 1.7 2020/03/02 11:34:3
<input type="checkbox"/>	1 13990324.log	OK	2020/06/13	<input type="checkbox"/>	13981212.log 1.6 2020/03/02 11:34:3
<input type="checkbox"/>	2 13990325-Survey.I...	New	2020/06/14	<input type="checkbox"/>	13990217-Survey.log 2.5 2020/05/06 06:42:1
<input type="checkbox"/>	3 13990325.log	New	2020/06/14	<input type="checkbox"/>	13990217.log 2.4 2020/05/06 06:42:1
<input type="checkbox"/>	4 13990326-Survey.I...	New	2020/06/15	<input type="checkbox"/>	13990324-Survey.log 3.3 2020/06/13 11:02:3
<input type="checkbox"/>	5 13990326.log	OK	2020/06/15	<input type="checkbox"/>	13990324.log 3.1 2020/06/13 11:02:3
<input type="checkbox"/>	6 13990327-Survey.I...	OK	2020/06/16	<input type="checkbox"/>	13990326.log 4.7 2020/06/15 09:06:2
<input type="checkbox"/>	7 13990327.log	OK	2020/06/16	<input type="checkbox"/>	13990327-Survey.log 6.6 2020/06/16 11:02:1
<input type="checkbox"/>	8 13990329-Survey.I...	Update	2020/06/18	<input type="checkbox"/>	13990327.log 7.0 2020/06/16 11:02:1
<input type="checkbox"/>	9 13990329.log	OK	2020/06/18	<input type="checkbox"/>	13990329-Survey.log 8.2 2020/10/12 03:26:4
<input type="checkbox"/>	10 13990331-Survey.I...	OK	2020/06/20	<input type="checkbox"/>	13990329.log 7.8 2020/06/18 07:58:1
<input type="checkbox"/>	11 13990331.log	OK	2020/06/20	<input type="checkbox"/>	13990331-Survey.log 3.3 2020/06/20 07:58:3
<input type="checkbox"/>	12 13990402-Survey.I...	OK	2020/06/22	<input type="checkbox"/>	13990331.log 3.1 2020/06/20 07:58:3
<input type="checkbox"/>	13 13990402.log	OK	2020/06/22	<input type="checkbox"/>	13990402-Survey.log 3.3 2020/06/22 08:43:3
<input type="checkbox"/>	14 13990403-Survey.I...	OK	2020/06/23	<input type="checkbox"/>	13990402.log 3.1 2020/06/22 08:43:3

Files: 247







Software main window



2D and 3D graph

Ordering info

Standard package includes

Part #	Image	Description
SPECT2113		Portable digital spectrometer NaI(Tl) crystal 2"x2"
ACCE2113001		CD user guide (1 Pack)
ACCE2113003*		Guaranty (one year)
ACCE2113007		Hard case with foam insert
ACCE2113011		Car kit battery charger (1 Pack)
ACCE2113012		One battery charger (1 Pack)
ACCE2113013		Cable USB 2.0 (A) to Mini USB (B) Cable (1 Pack)

* =we stand behind our products. We guarantee your satisfaction in the quality of our instruments by providing a complete one-year warranty covering any defect of workmanship, material, and/or design. If our products do not perform, we will provide complete repair and/or replacement. for guaranty conditions, please refer to manual device (SPECT2113- Manual)

Optional accessories and services

Part #	Image	Description
ACCE2113004		Installation
ACCE2113005		Training
ACCE2113006**		Re-Calibration (Interval) services. 1year factory maintenance suggested
ACCE2113016		Single-ended sealed mini USB cable, Type A Plug to Mini Type B Plug, 2m length
ACCE2113017		USB to USB extenuation Cable 10,15, 20, 30 meters
ACCE2113018		Remote reader Software

** = The proper maintenance & calibration of your instruments is critical to ensure proper performance & accuracy. for Re-calibration (Interval) services, please call with CFP company (021- 46045383)





Innovator in Spectroscopy Equipment



Unit 10, No 64, Vahedi
(7) St, After Punak Sq,
Ashrafi Esfahani Expy,
Tehran, Iran



+98 (21) 46045383

w w w . c f p . c o . i r